

SWITCH ACTUATOR

SAS-08.16

BASIC INFORMATION

The switch actuator receives KNX telegrams and switches up to 8 independent loads. Each output has a bistable relay, which can be manually controlled.

- 8 independent channels for a maximum capacitive load of 140μF
- Ability to connect outputs to different phases
- Manual control of outputs using front panel buttons
- LED indication of output status
- Extended logic and scenario functions for each output
- Ability to select output mode (NO or NC)
- Saving settings during a KNX power failure
- Power supply via KNX bus
- DIN rail 35mm mounting

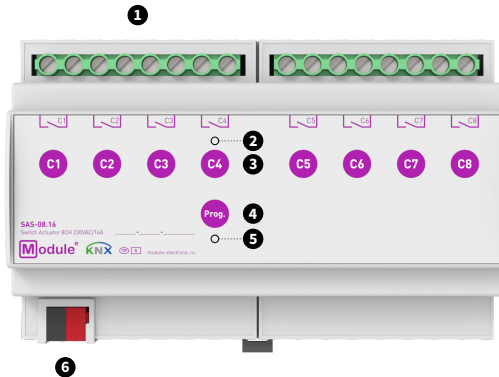

1. Outputs
2. Output status indicator LED
3. Output control button
4. Programming button
5. Programming LED
6. KNX connector

SPECIFICATIONS

Device model	SAS-08.16	
Outputs (control channels)		
Number of outputs	8	
Output type / Disconnection type	Potential-free outputs-bistable relay with tungsten pre-make contact / Micro-disconnection	
Rated current per output	16A/230V AC, 16A/24V DC	
Capacitive load	140µF	
Maximum switching voltage	400V AC, 300V DC	
Maximum load (resistive / inductive)	4000W / 1500W	
Maximum inrush current	165A/20ms 800A/200µs	
Maximum relay response time	10ms	
Maximum load per output		
Incandescent lamps	2500W	
Halogen lamp 230V	2500W	
Halogen lamp, electronic transformer	1500W	
Fluorescent lamp not compensated	2300W	
Fluorescent lamp parallel compensated	1500W	
Maximum number of electronic transformers	20	
Cross-section of the connected wire to the screw terminals	1 x (0,5-4mm ²)	2 x (0,5-2,5mm ²)
Mechanical lifetime of the relay (cycles, minimum)	3.000.000	
KNX interface		
Specification	TP-256	
Available application software	ETS 5	
KNX connector	4-wire EIB connector (PUSH WIRE spring clips) for standard cable TP1 0,8mm Ø	
Power supply	via KNX bus	
Consumption on the KNX bus (29V DC)	< 5mA	< 150mW
Operation temperature	0°C .. + 45°C	
Operation humidity	5 .. 95% (no condensation)	
Degree of protection	IP 20, clean environment	
Mounting type	DIN rail 35mm	
Dimensions	142,3 x 90,5 x 62mm (8TE)	
Weight	340g	

INSTALLATION

Attaching to DIN rail

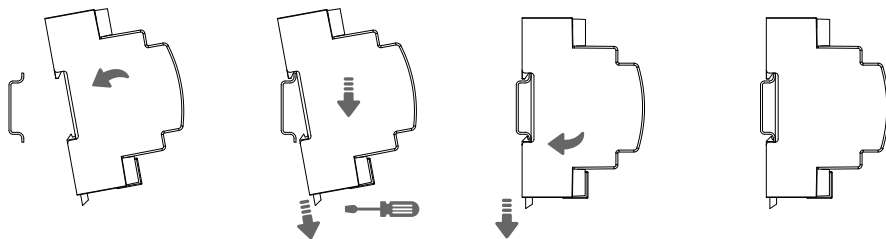

Removing from DIN rail

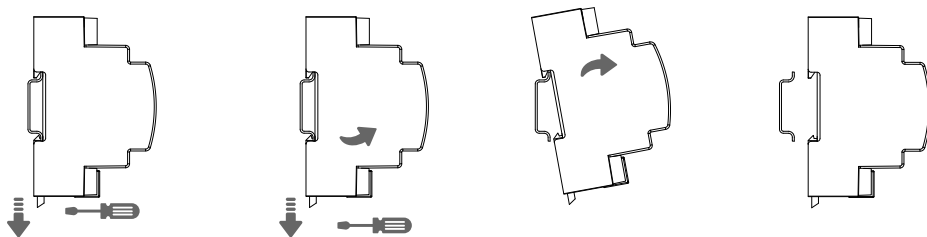

WIRING DIAGRAMS

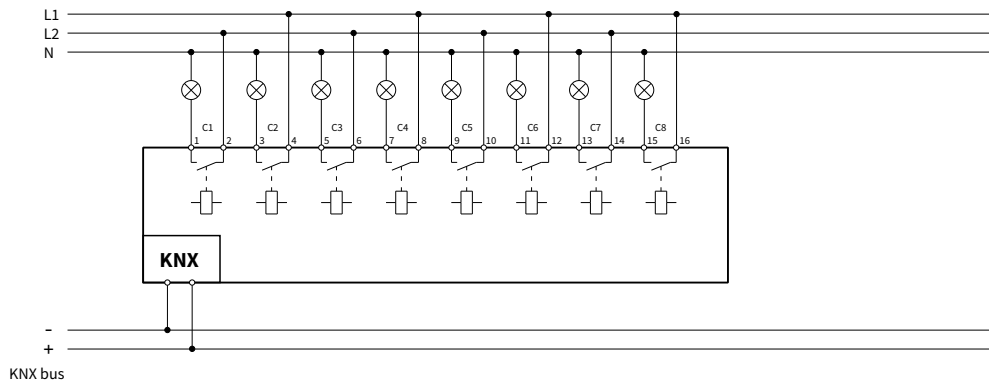

SAFETY INSTRUCTIONS



ATTENTION! Installation and connection of the device to the mains must only be carried out by qualified personnel! There is a risk of electric shock! Be sure to turn off the power before installing or removing the device! Even when the device is turned off, the output terminals can be live! Do not connect to the outputs a load that exceeds the recommended values! The design of the device meets the requirements of electrical safety according to GOST 12.2.007.0-75.



SETTING INSTRUCTIONS

The device is set up in accordance with the instruction manual. (The full manual and application program can be downloaded at <https://module-electronic.ru/documents> or by scanning the QR code at the bottom of the document).

TRANSPORTATION, STORAGE AND DISPOSAL

The conditions for the transportation of devices must comply with conditions 5 of GOST 15150-69. Storage of devices in packaging at the warehouses of the manufacturer and consumer must comply with storage conditions 1 in accordance with GOST 15150-69. After transportation or storage at low temperatures, it is necessary to withstand the device at room temperature for at least 2 hours before turning it on. Do not dispose of the device with household waste.

WARRANTY

Warranty period - 12 months from the date of sale to the consumer. The manufacturer is not liable and does not indemnify for damage caused by the fault of the consumer in case of non-compliance with the conditions of transportation, storage, installation and operation, as well as in case of violation of the seal when trying to repair the device yourself.

All the necessary information on the warranty can be obtained by the consumer by calling Module Electronics or on the website: www.module-electronic.ru.

Serial number _____

Date of sale _____

seller's stamp

Seller Signature _____

Name, address of the trading organization _____

User Manual



Made in Russia

module-electronic.ru